

FLOS



■ F7542031 Matte Black

To-Tie T2 NEW

Designed by Guglielmo Poletti, 2022



7W - 336lm - 2700K - CRI> 90

Designed by Guglielmo Poletti Table lamp providing diffused light. Clear glass cylindrical lamp body available in multiple sizes. The handle is made of aluminum and also acts as a light emitter. Multi-led diffuser in specially designed white polycarbonate to avoid the Multi Shadow effect and dazzle. High efficiency LED source with a lifetime of more than 50.000 hours. Electric cable of useful length 180 cm, covered in black fabric and equipped with dimmer switch for ON/OFF and adjustment of the light flow between 10-100%. Plug-in power supply with interchangeable plugs. To-Tie is a future-proof lamp as no glue is used to assemble its different parts. The product can therefore be separated, replaced individually, and recycled separately.

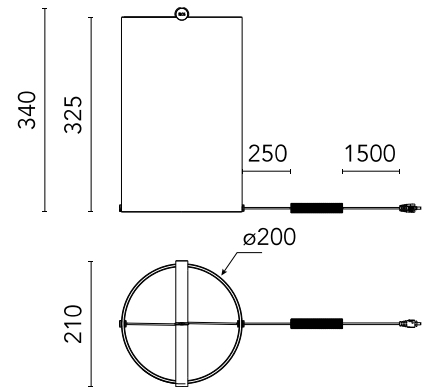

Are you a professional and your project needs consulting and support?

[BOOK AN APPOINTMENT](#)

Main specifications

EAN	8059607047620
Mounting	Table
Environments	Indoor dry location
Light Source Type	LED
LED type	LED Module
Power (W)	7
System flux (lm)	336

Physical

Colour	Matte Black
Net weight (kg)	2.5
Package volume (m3)	0.04
IP internal	20
H2O stop	No

Download

Mounting instructions [↓ PDF](#)

Photometric Files

LDT / IES [↓ ZIP](#)

Technical Drawings

2D [↓ ZIP](#)

3D [↓ ZIP](#)



Schematic light drawing

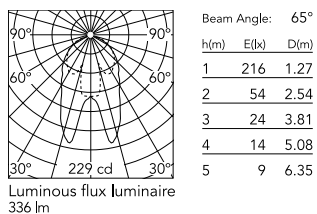

Photometric

Lighting type	Direct
Light distribution	Asymmetric
CCT (K)	2700
CRI>	90

Electrical

Insulation class	III
Frequency (Hz)	50/60
Main voltage (Vac)	24
LED voltage Vf (Vdc)	24.00
LED current (mA)	500
Driver	Remote included
Dimmable	Yes
Dimming type	Electronic 24V
Dimming interface	Dimmer Integrated
Plug type	Type G, Type A, Type C

Ecodesign and Energy Labelling

This product contains a light source of energy efficiency class F



Replaceable (LED only) light source by an end-user

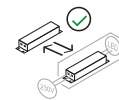

Replaceable control gear by an end-user

Spare Parts



01. Black plug assembly kit & 24V driver RF3320100



RF3320100

Black plug assembly kit & 24V
driver